

Art nr:	Benämning	Utpris	Artikel grupp 0931
2343575	M 10 A	70,00	
2343576	M 12 A	99,00	
2343577	M 16 A	146,00	
2343578	M 20 A	190,00	
2343579	M 24 A	537,00	
2343580	M 10 B	139,00	
2343581	M 12 B	198,00	
2343582	M 16 B	292,00	
2343583	M 20 B	379,00	
2343584	M 24 B	1 073,00	

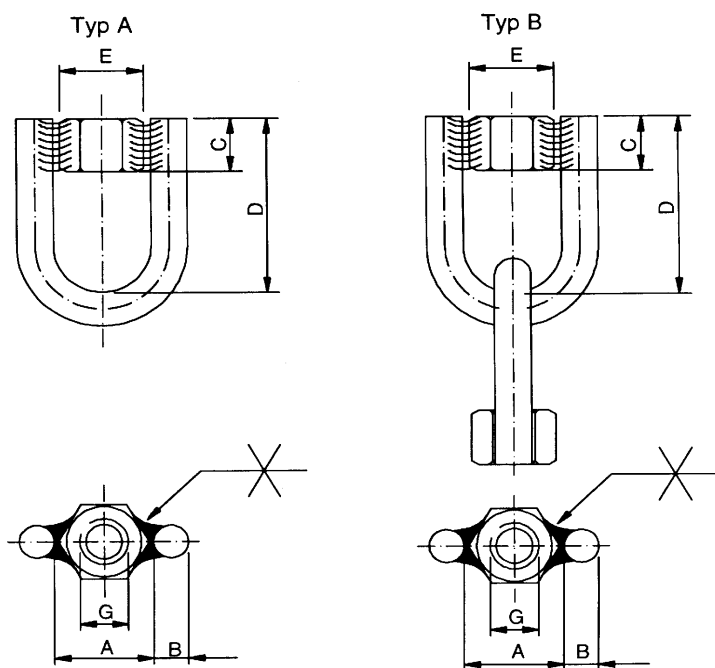

Nr	Avsedd för rör Dy	A ±1	B	C	D	E	G	Max last kN (kp)	Vikt kg	
									Typ A	Typ B
10	13 - 49	20	8	12	60	18,6	M 10	5 (500)	0,09	0,18
12	50 - 90	23	10	15	60	21,9	M 12	8 (800)	0,12	0,24
16	98 - 196	29	12	19	80	27,7	M 16	13 (1300)	0,38	0,76
20	203 - 378	36	16	22	85	34,6	M 20	20 (2000)	0,65	1,30
24	403 - 610	43	20	27	115	41,6	M 24	35 (3500)	1,32	2,65